

SERVOSTAR™ CD SERIES 5

www.DanaherMotion.com



High Performance Servo Drive

The SERVOSTAR™ CD is a high-performance digital servo drive, supporting Current, Velocity or Position Control mode. Numerous Control options are offered, ranging from the classical ± 10 VDC command, through encoder following and pulse-and-direction, all the way to SERCOS control. Choose from four velocity control algorithms to optimize performance on your system, and use the Auto-tune function to quickly and easily achieve high performance operation.

The SERVOSTAR™ has been designed to be a multi-purpose servo drive, capable of driving a vast product basket of motors and their assorted feedback devices. The drives come in standard packages of 3, 6, and 10 amp sizes. All are packaged in a small frame size for minimizing cabinet space. The servo drives are connected directly to the line for power. The SERVOSTAR™ CD has a very intuitive setup process which makes the servo drive easy to use while providing leading edge performance.

KOLLMORGEN™

SERVOSTAR CD Series 5 and AKM Series Motors
High Performance Servo Drives and Motors



For Further Information Contact

Heason Technologies Group Ltd

Tel: +44(0)1403 755800

Fax: +44(0)1403 755810

Email: sales@heason.com

Freephone 0800 374903 www.heason.com

Heason
Technologies Group

High Performance Servo Drive

- Fully digital current, velocity and position servo loops
- Sinusoidal Commutation, providing high resolution with low distortion
- Choice of incremental encoder, resolver, or sine encoder feedback
- SERCOS, Serial or ± 10 VDC Analog command
- 3 amps to 10 amps continuous current
- Single- and three-phase power
- Self protecting power stage
- PWM switching frequency up to 16kHz with 2x current ripple
- Optional 24 VDC logic input supply, to separate from mains supply
- Easy tuning and setup using **MOTIONLINK®** for Windows™
- Optional DeviceNet Position Controller interface
- Six digital inputs, one digital output, one analog input, one analog output
- Up to 16 step motion buffer for indexing or positioning applications

Features

Feedback

- Resolver, Incremental encoder, Sine encoder or Halls-only operation
- Auxiliary encoder feedback, used for Dual loop or Master/Slave operation
- Commutation initialization without motion

Servo Control

- Fully digital current, velocity and position loops
- Advanced patented sinewave commutation technology provides smooth, precise low-speed control as well as high-speed performance
- Accurate torque control due to precision balanced current loops with closed loop sensors
- Patented torque angle control enhances motor performance
- Velocity loop bandwidths up to 400Hz
- Self-tuning velocity loop algorithm

Reference Command

- 14-bit Analog-to-Digital conversion for ± 10 VDC operation
- SERCOS operation, designed for use with Kollmorgen's SERVOSTAR™ MC multi-axis motion controller
- Pulse-following control, configured as an encoder follower, up/down counter, or pulse/direction counter
- Serial command using RS232 or RS485
- DeviceNet position controller option

Motion Options

- Point-to-point, incremental or absolute indexing or positioning
- Stores up to 16 motion indexing profiles in memory
- Homing functions
- Electronic gearing

Configurable I/O

- 6 digital inputs and 1 digital output, configurable to a variety of functions
- Analog output for monitoring various parameters

Robust Design

- Self-protecting power modules
- Full protection against short circuit, over-voltage, under-voltage, motor and drive over-temperature, over-current and feedback loss
- Flexible current foldback protection
- Proven reliability

Agency Compliant

- UL508C registered
- CE mark

Motor & Servo Drive Ordering Information

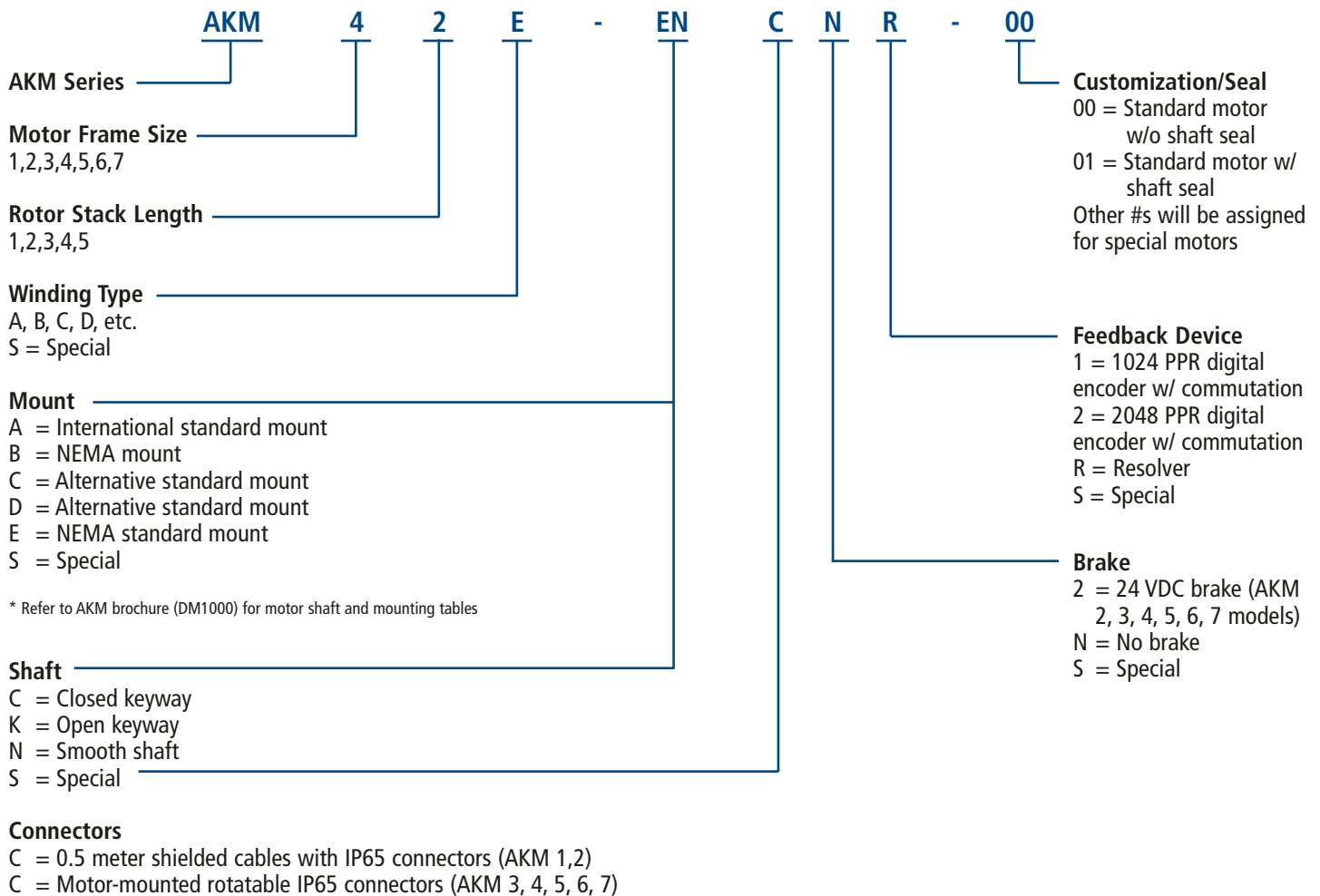

Servo Drive Ordering Information

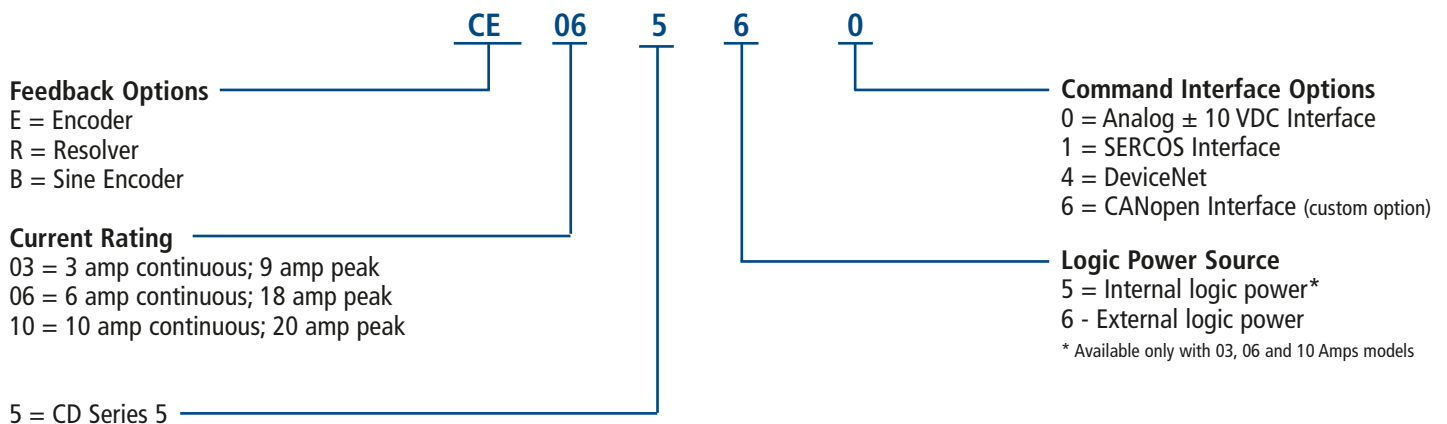

Specifications

Servo Drive		Cx03	Cx06	Cx10
Input Voltage	Control logic	24 VDC (external logic option)		
	AC Line Voltage	115/230, 1 or 3 Phase	115/230, 1 or 3 Phase	230, 3 Phase
Output Current	Continuous (A rms / per phase)	3	6	10
	Peak time (sec)	.5	.5	2
	Peak (A rms)	9	18	20
Performance	Current loop BW (max KHz)	2.5		
	Current loop update rate KHz	16		
	Velocity loop BW (max Hz)	400		
	Velocity update rate (Hz)	4000		
	Position Loop Update rate (Hz)	2000		
Analog Resolution	Bits	14		

Options

Cable Sets	
CS-SS-RHA1HE-xx	Power and feedback cables for resolver based systems. IP65 connector at motor end and D-Sub connector at drive end for feedback.
CS-SS-RHAAHBE-xx	Power and feedback cables for resolver based systems with a brake. IP65 connector at motor end and D-Sub connector at drive end for feedback.
CS-SS-CHA1HE-xx	Power and feedback cables for encoder based systems. IP65 connector at motor end and D-Sub connector at drive end for feedback.
CS-SS-CHAAHBE-xx	Power and feedback cables for encoder based systems with a brake. IP65 connector at motor end and D-Sub connector at drive end for feedback.

* xx requires a length in meters with options from 01, 03, 06 up to 75 meters in 3 meter increments.

Connector Kit	
CK 100	Mating plugs for C1, C2, C4, C7 and C8 Connectors

Regenerative Resistor Kit	
ERH-26	200 watts of shunt regulation for rapidly decelerating loads

Serial Cable	
A-97251-004	RS232 Serial Communications Cable, 2 meters long

DANAHER MOTION is a registered trademark of Danaher Corporation. Danaher Motion makes every attempt to ensure accuracy and reliability of the specifications in this publication. Specifications are subject to change without notice. Danaher Motion provides this information "AS IS" and disclaims all warranties, express or implied, including, but not limited to, implied warranties of merchantability and fitness for a particular purpose. It is the responsibility of the product user to determine the suitability of this product for a specific application. ©2004 Danaher Motion.

Specifications

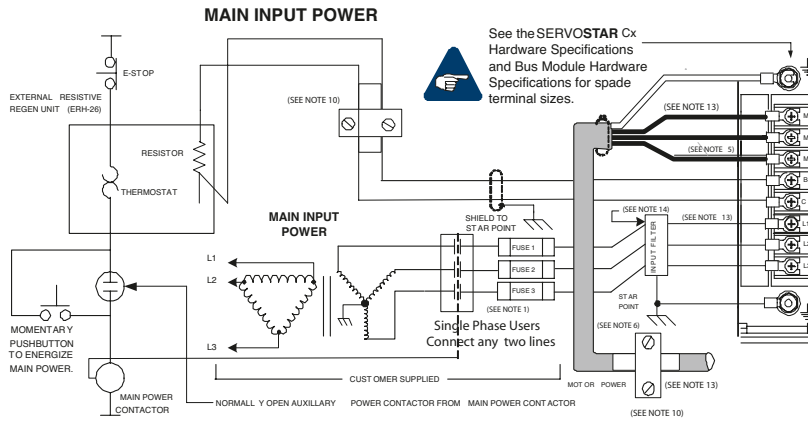

- Note 1** FUSE 2 and contactor are not required if the input power line is neutral.
- Note 5** All AC line wires should be a twisted pair.
- Note 6** The ground of the drive and motor best minimizes ground currents and noise when connected in a "star point" configuration.
- Note 10:** Cables should be properly bonded to the back panel and implemented as close to the drive side of the cable as possible for effective grounding. If bonding is installed, the shield on the cable end need not be connected to the "star point" configuration. Only connect the shield on one end of the cable (preferably on the drive side).
- Note 13:** See the SERVOSTAR Cx Hardware Specifications and Bus Module Hardware Specifications for wire gauge and ferule sizes.
- Note 14:** See CE Filtering Techniques for further information.

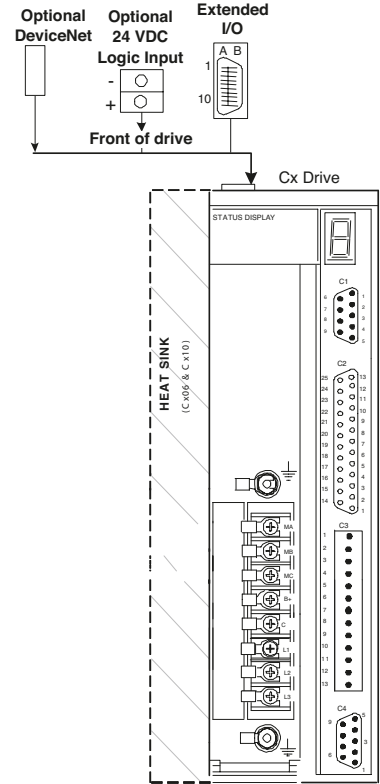

C1 COMMUNICATIONS (D9S)

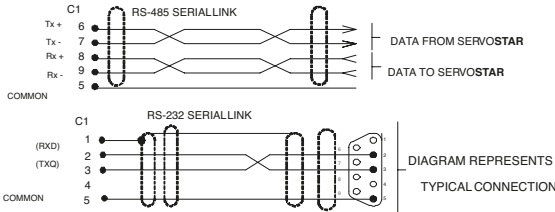

Do NOT connect unused pins on C1 connector. Connecting all the pins on some manufacturers' cables produce unpredictable results.

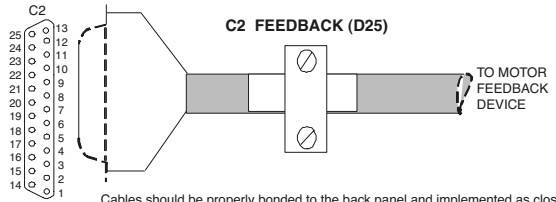

Cables should be properly bonded to the back panel and implemented as close to the drive side of the cable as possible for effective grounding. If bonding is installed, the shield on the cable end need not be connected to the "star point" configuration. Only connect the shield on one end of the cable (preferably on the drive side).

See the SERVOSTAR Cx Hardware Specifications and Bus Module Hardware Specifications for wire gauge and ferule sizes.

C3 CONFIGURABLE I/O INTERFACE (SEE NOTE 13)

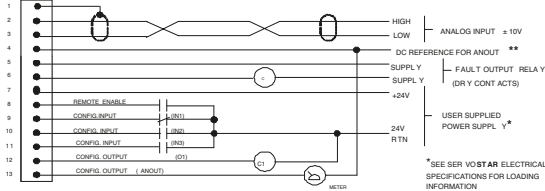

A flyback diode is necessary for inductive loads connected across the O1 output.

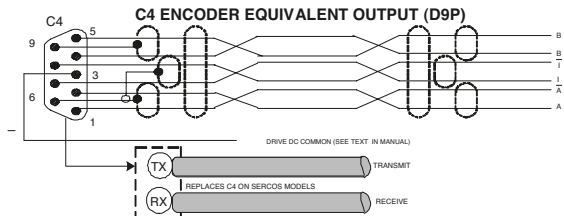

INTERNAL DC COMMON FOR REFERENCING ANOUT. IT IS ALSO PROVIDED TO THE ELECTRICAL EQUIPMENT COMMONS TOGETHER INSIDE THE DRIVE TO PREVENT EXCESS COMMON MODE VOLTAGES FROM DESTROYING I/O (INTERNAL FUSING).

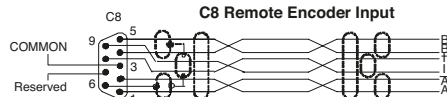

DANAHER MOTION is a registered trademark of Danaher Corporation. Danaher Motion makes every attempt to ensure accuracy and reliability of the specifications in this publication. Specifications are subject to change without notice. Danaher Motion provides this information "AS IS" and disclaims all warranties, express or implied, including, but not limited to, implied warranties of merchantability and fitness for a particular purpose. It is the responsibility of the product user to determine the suitability of this product for a specific application. ©2004 Danaher Motion.

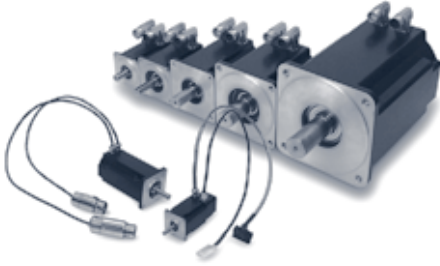

The advanced Kollmorgen AKM high performance motor series offers a wide range of mounting, connectivity, feedback and other options. These motors offer superb flexibility to meet application needs with:

- 7 frame sizes
- 25 frame/stack combinations
- 77 'standard' windings
- Fail-safe brakes
- Shaft seals
- Shaft and mounting variations
- Custom windings
- Connectivity

AKM motors offer extremely high torque, density and acceleration

Torque

0.16 to 53 N-m continuous stall torque (1.4 to 470 lb-in) in 25 frame/stack combinations. Specific torques are often available from multiple frame sizes to optimize mounting and inertia matching capabilities.

Speed

Speeds to 8000 rpm meet high speed application requirements. Windings specifically tailored to lower speeds are also available.

Voltage

AKM motors can be applied to all standard global voltages. Windings are specifically tailored to 75 VDC, 120 and 240 VAC.

Mounting

Multiple mounting standards are available to meet common European, North American, and Japanese standards.

Feedback

AKM motors include resolver or encoder (commutating) options to meet specific requirements.

Smoothness

Smooth performance results from low-cog, low-harmonic distortion magnetic designs.

Connectivity

Rugged, rotatable IP65 connectors and low cost Molex plugs are both available to provide flexibility.

Thermal

Windings are rated conservatively at 100°C rise over a 40°C ambient while using 155°C (class F) insulation materials. Motors meet all UR, cUR and CE requirements and include thermistors. Thermal ratings at 60°C rise are also provided to meet the needs of specific applications.

Danaher Motion Cables offer the Complete Solution

Factory cables are provided for your convenience and offer high reliability to keep your application running day and night. The new "Value" line provides a cost saving option for applications that don't require long distances or encounter extreme environmental conditions.

Please consult your local salesperson or contact the Danaher Motion Customer Support Center to decide which cable option is best suited for your application.

How To Build a Servo Drive & Motor System

Definitions:

T_{ps}	Peak stall torque for system
T_{ms}	Peak torque at maximum speed
T_{cs}	Continuous torque at stall
T_{cr}	Continuous rated torque (torque at rated power)
ω_{max}	Maximum speed
ω_r	Rated speed (speed at rated power)
ω_k	Speed at knee in peak envelope (intersection of system peak torque with voltage limit line)

System torque/speed information on the following pages is designed to help you select the optimum brushless servo motor/controller combination. The nominal values in this data illustrate performance for recommended motor/controller systems.

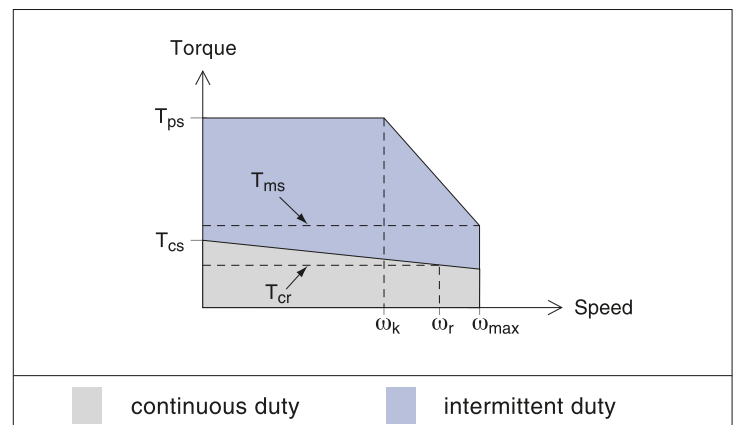

Recommended Motor/Servo Drive Systems, 240 VAC, 320 VDC bus¹

Servo Motor Model	Servo Drive Model	Peak Stall Torque Tps N-m (lb-in)	Peak Torque at Max. Speed Tms N-m (lb-in)	Cont. Stall Torque Tcs N-m (lb-in)	Cont. Rated Torque Tcr N-m (lb-in)	Speed at Knee ωk rpm	Rated Speed ωr rpm	ωmax. Speed ωmax rpm	Cont. Stall Current Ics Arms	Current@Peak Torque Ips Arms	Inertia j kg-cm ² (lb-in-s ² x 10 ⁻³)
AKM11B	Cx035xx	0.61 (5.39)	0.584 (5.17)	0.18 (1.62)	0.17 (1.47)	7,700	8,000	8,000	1.16	4.7	0.017 (0.015)
AKM12C	Cx035xx	1.08 (9.54)	1.05 (9.29)	0.31 (2.74)	0.28 (2.47)	7,880	8,000	8,000	1.51	6.1	0.031 (0.0274)
AKM13C	Cx035xx	1.46 (12.9)	1.06 (9.38)	0.41 (3.62)	0.36 (3.22)	6,080	8,000	8,000	1.48	5.9	0.045 (0.0389)
AKM22E	Cx035xx	2.42 (21.4)	1.61 (14.2)	0.87 (7.71)	0.7 (6.18)	6,010	8,000	8,000	2.73	9.0	0.161 (0.143)
AKM23D	Cx035xx	3.84 (34)	0.0 (0.0)	1.16 (10.2)	1.03 (9.08)	3,020	5,000	6,540	2.19	8.8	0.216 (0.191)
AKM23F	Cx065xx	3.52 (31.2)	3.28 (29.0)	1.18 (10.4)	0.94 (8.28)	7,670	8,000	8,000	4.31	15.0	0.216 (0.191)
AKM24D	Cx035xx	4.76 (42.1)	0.0 (0.0)	1.41 (12.4)	1.29 (11.4)	2,620	4,000	5,420	2.21	8.8	0.27 (0.239)
AKM24F	Cx065xx	4.68 (41.4)	2.42 (21.4)	1.42 (12.6)	1.12 (9.91)	5,570	8,000	8,000	3.89	15.0	0.27 (0.239)
AKM31E	Cx065xx	3.24 (28.6)	0.77 (6.82)	1.2 (10.7)	0.95 (8.41)	5,000	6,000	8,000	2.99	9.0	0.33 (0.292)
AKM32D	Cx035xx	7.05 (62.4)	0.0 (0.0)	2.04 (18.0)	1.93 (17.1)	1,670	2,500	3,750	2.23	8.9	0.59 (0.522)
AKM32H	Cx065xx	5.36 (47.5)	2.87 (25.4)	2.1 (18.6)	1.45 (12.8)	6,560	7,000	8,000	5.50	15.0	0.59 (0.522)
AKM33E	Cx035xx	8.95 (79.3)	0.0 (0.0)	2.79 (24.7)	2.62 (23.2)	1,640	2,000	3,140	2.58	9.0	0.85 (0.752)
AKM33H	Cx065xx	7.35 (65.0)	0.0 (0.0)	2.88 (25.5)	2.27 (20.1)	5,040	5,500	6,630	5.62	15.0	0.85 (0.752)
AKM41E	Cx035xx	5.33 (47.2)	0.0 (0.0)	2.02 (17.8)	1.82 (16.1)	2,140	3,000	4,850	2.85	9.0	0.81 (0.717)
AKM41H	Cx065xx	4.78 (42.3)	3.8 (33.6)	2.06 (18.2)	1.62 (14.3)	5,070	6,000	6,000	5.60	15.0	0.81 (0.717)
AKM42E	Cx035xx	9.72 (86.0)	0.0 (0.0)	3.42 (30.3)	3.12 (27.6)	1,260	1,800	2,740	2.74	9.0	1.45 (1.28)
AKM42G	Cx065xx	9.56 (84.6)	0.0 (0.0)	3.53 (31.2)	2.9 (25.7)	2,530	3,500	4,660	4.80	15.0	1.45 (1.28)
AKM42J	Cx105xx	7.75 (68.6)	6.52 (57.7)	3.56 (31.5)	2.38 (21.0)	5,460	6,000	6,000	8.40	20.0	1.45 (1.28)
AKM43G	Cx065xx	13.2 (116)	0.0 (0.0)	4.8 (42.5)	4.0 (35.4)	2,000	2,500	3,470	4.87	15.0	2.09 (1.85)
AKM43K	Cx105xx	9.66 (85.5)	5.44 (48.1)	4.9 (43.4)	2.62 (23.2)	5,120	6,000	6,000	9.60	20.0	2.09 (1.85)
AKM44G	Cx065xx	16.1 (142)	0.0 (0.0)	5.88 (52.0)	4.9 (43.4)	1,760	2,000	2,890	5.00	15.0	2.73 (2.42)
AKM44J	Cx105xx	12.9 (114)	0.0 (0.0)	6.0 (53.1)	3.84 (34)	3,800	4,000	5,010	8.80	20.0	2.73 (2.42)
AKM51G	Cx065xx	11.7 (104)	0.0 (0.0)	4.75 (42.1)	4.03 (35.6)	1,910	2,500	3,480	4.84	14.5	3.42 (3.03)
AKM51K	Cx105xx	9.22 (81.6)	4.43 (39.2)	4.9 (43.4)	2.35 (20.8)	4,740	5,500	6,000	9.40	20.0	3.42 (3.03)
AKM52G	Cx065xx	21.5 (191)	0.0 (0.0)	8.43 (74.6)	7.69 (68.1)	1,110	1,500	1,920	4.72	14.2	3.22 (5.51)
AKM52K	Cx105xx	16.9 (150)	0.0 (0.0)	8.6 (76.1)	6.8 (60.2)	2,820	3,000	3,690	9.30	20.0	3.22 (5.51)
AKM53K	Cx105xx	22.9 (203)	0.0 (0.0)	11.6 (103)	10.1 (88.9)	2,220	2,000	2,780	9.40	20.0	9.12 (8.07)
AKM54K	Cx105xx	28.1 (249)	0.0 (0.0)	14.4 (127)	12.7 (112)	1,880	1,800	2,290	9.70	20.0	11.9 (10.6)
AKM62K	Cx105xx	22.7 (201)	0.0 (0.0)	12.2 (108)	10.4 (92)	1,870	2,000	2,700	9.60	20.0	16.9 (15.0)
AKM63K	Cx105xx	31 (274)	0.0 (0.0)	16.8 (149)	14.9 (131)	1,510	1,500	2,020	9.90	20.0	24.2 (21.4)

¹ See detailed motor specifications in the AKM brochure beginning on page 15 of the AKM Selection Guide.

SERVOSTAR CD Cx03/06/10*

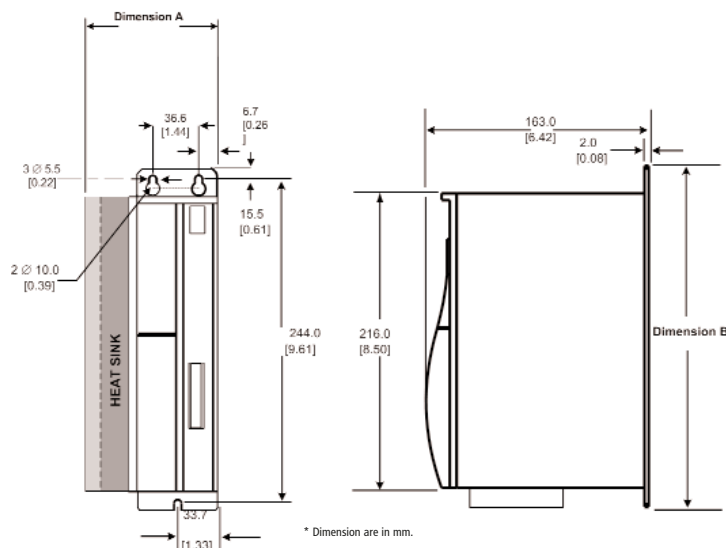

Model	Size (amp)	Dim. "A"	Dim. "B"
Cx03	3	67.4 (2.65)	256.0 (10.08)
Cx06	6	88.4 (3.48)	256.0 (10.08)
Cx10	10	99.1 (3.90)	256.0 (10.08)

DANAHER MOTION is a registered trademark of Danaher Corporation. Danaher Motion makes every attempt to ensure accuracy and reliability of the specifications in this publication. Specifications are subject to change without notice. Danaher Motion provides this information "AS IS" and disclaims all warranties, express or implied, including, but not limited to, implied warranties of merchantability and fitness for a particular purpose. It is the responsibility of the product user to determine the suitability of this product for a specific application. ©2004 Danaher Motion.

KOLLMORGEN™



203A West Rock Road
Radford, Va 24141

DANAHER MOTION is a trademark.

Danaher Motion makes every attempt to ensure accuracy and reliability of the specifications in this publication. Specifications are subject to change without notice. Danaher Motion provides this information "AS IS" and disclaims all warranties, express or implied, including, but not limited to, implied warranties of merchantability and fitness for a particular purpose. It is the responsibility of the product user to determine the suitability of this product for a specific application.

©2004 Danaher Motion. Supplier XK KP 6-14-04 200404-08.qxd DSAC-02.8-041904-1

FOR IMMEDIATE ASSISTANCE:

Address: Danaher Motion
203A West Rock Road
Radford, VA 24141 USA

Fax: 1-540-639-4162

Email: Customer.Support@DanaherMotion.com

Phone: 1-540-633-3400

Internet: www.DanaherMotion.com
